



# AIR Traffic Display

## Pilot's Manual

Document: MAN0020A0001  
Version: 3.0  
Date: 2019/05/09



Please read this manual carefully before using the device.

Observe limitations and safety instructions.

This manual is an essential portion of the device and must be kept in a safe place.

## Articles Covered

This manual covers the following articles:

- ATD-11 "AIR Traffic Display 11"
- ATD-57 "AIR Traffic Display 57"
- ATD-80 "AIR Traffic Display 80"

## Revision History

<i>Rev.</i>	<i>Date</i>	<i>Status</i>	<i>Author</i>	<i>Changes</i>	<i>Approved</i>
0.1	2016/02/24	Draft	M. Förderer	initial Draft	–
0.9	2016/06/08	Draft	M. Förderer	Release Candidate	–
1.0	2016/07/05	Release	M. Förderer	First Release	Tobias Fetzter
1.1	2016/07/29	Release	M. Förderer	Minor changes, added database information and some items to the troubleshooting chapter	–
1.2	2016/11/09	Release	M. Förderer	Added changes and new functions from software version 1.2	–
1.3	2016/11/24	Draft	M. Förderer	Added alert zone features in version 1.3	–
1.5	2017/04/20	Draft	M. Förderer	Added version 1.5 features and boot-loader update functions	–
2.0	2017/05/22	Release	H. Hoeth	Document restructuring	Hendrik Hoeth
2.1	2017/06/23	Release	M. Förderer	Added details in within the scope of FLARM compatibility certification	–
2.2	2018/03/13	Release	M. Förderer	Updated manual for software version 1.8	–
2.3	2018/03/13	Release	M. Foerderer	Minor Corrections	–
3.0	2019/05/09	Release	M. Förderer	Software Version 21 and new hardware versions ATD-11 and ATD-80	–

## Product Support

If you have questions, our product support team will be happy to help you. Contact us via [support@air-avionics.com](mailto:support@air-avionics.com) or by phone. Please find details about our hotlines and availability online at <http://www.air-avionics.com>

# Contents

## Getting Started · 1

Introduction · 1

Pilot Controls · 3

microSD Card Slot · 5

Basic Operation · 6

Limitations and Safety Instructions · 7

## Traffic Display · 9

Main Radar View · 9

Target Symbology · 9

## Target Selection · 12

Overview · 12

Target-Menu · 12

Quick Selection · 14

Target Out-Of-Range · 16

## Warning Functions · 18

Normal Traffic Warnings · 18

Head-On Traffic Warnings · 19

Nondirectional traffic warnings · 19

Obstacle Warnings · 20

Alert Zone Warnings · 20

Suppressing Warnings · 22

## System Configuration · 23

Configuration Operations · 23

Device Configuration · 23

Traffic View Configuration · 27

Traffic System Configuration · 30

## Software and Database Updates · 31

Version Identification · 31

Software and Database Loading · 31

Abnormal Operation · 35

Insufficient Data · 35

Failures · 37

Troubleshooting · 38

Configuration Menu Diagram · 40

FLARM EULA · 43



## 1.1 Introduction

AIR Traffic Displays, (in short simply called “ATD”) are Cockpit Displays of Traffic Information (CDTI). They display traffic data from connected collision avoidance systems or traffic receivers.

Three different hardware version of ATD are available to allow for best-possible integration into various types of aircraft. This manual covers all three versions as their operation, controls, and display content are identical.



Figure 1.1.: Three versions: ATD-11, ATD-57, and ATD-80

Multiple ATD can be used in a single aircraft. The small outline and multifunctional software of the device allow for better system integration in space constrained environments. The pilot-centered user interface aims at reducing crew workload, increasing crew efficiency and improving flight safety.

ATD displays traffic data from various systems, for example, AIR Traffic, TRX, FLARM, PowerFLARM, ZAON, or ADS-B traffic receivers. Comprehensive position and danger-level information on dangerous traffic is given. Optionally, detailed target informations are displayed. ATD is certified as “FLARM compatible” in the category “Standalone Display”.

ATD features a sunlight readable TFT display with two inch (ATD-57) or 2.7 inch (ATD-11 and ATD-80) screen diameter, field updateable software, and an integrated FLARMNet Database that can be updated using a mass storage device (microSD card). ATD emits aural alerts through an integrated warning sounder.

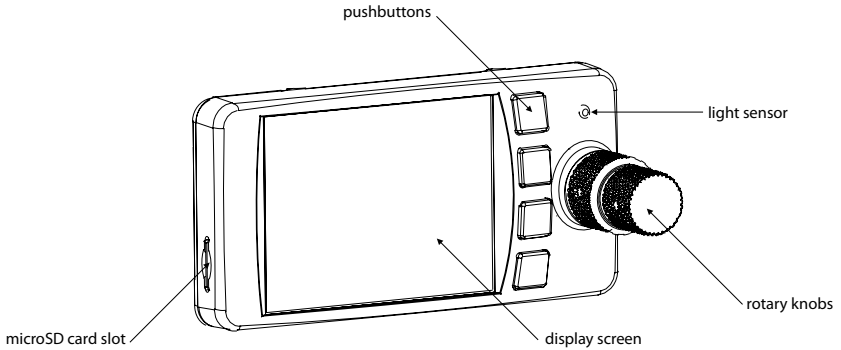

Figure 1.2.: ATD-11 front panel overview

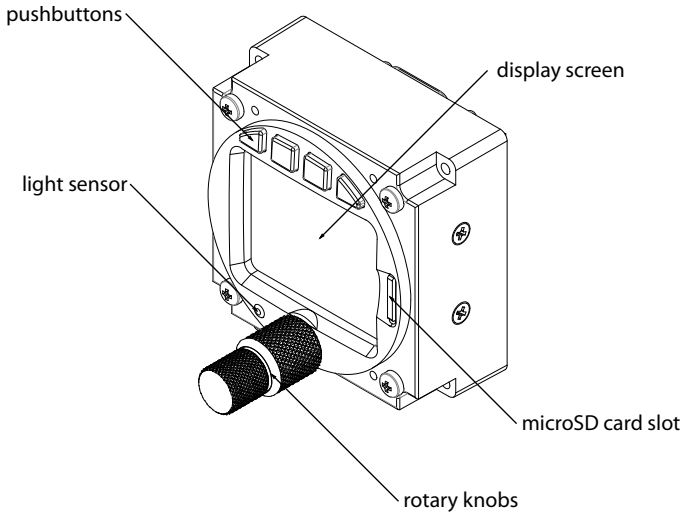

Figure 1.3.: ATD-57 front panel overview



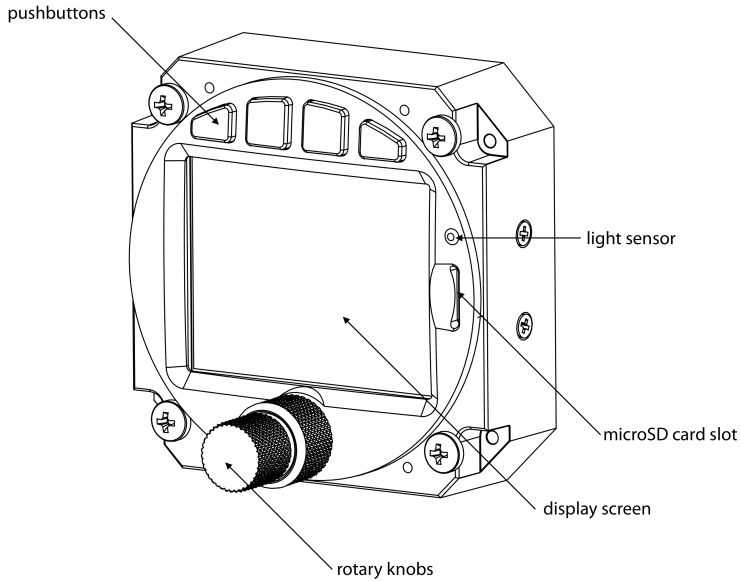

Figure 1.4.: ATD-80 front panel overview

## 1.2 Pilot Controls

Inner and outer knobs have 16 detents per revolution and can be rotated clockwise and counter-clockwise. The inner knob has a pushbutton. Four softkey-pushbuttons are located on the bezel along the top of the TFT-display.

### 1.2.1 Inner Knob Functions

- On the main radar page, the **inner knob** selects a traffic-target (if target selection is ON) or adjusts the display range (if target selection is OFF).
- In the menu, the **inner knob** controls the position of the menu focus.
- On text input pages the **inner knob** controls the text character.

All functions the **inner knob** controls are kept in the color *cyan*.

### 1.2.2 Inner Knob Pushbutton Functions

- On the main radar page, the **inner knob pushbutton** is used to open the traffic-target menu (short push).
- The **inner knob pushbutton** is used to open the configuration menu (long push).

- In the Menu, the **inner knob pushbutton** is used for menu-item execution/ENTER (short push).

### 1.2.3 Outer Knob Functions

- On the main radar page, the **outer knob** changes the display range (zoom).
- In the menu, the **outer knob** controls the position of the menu focus.
- On text input pages the **outer knob** controls the input position.

All functions the **outer knob** controls are kept in the color *green*.

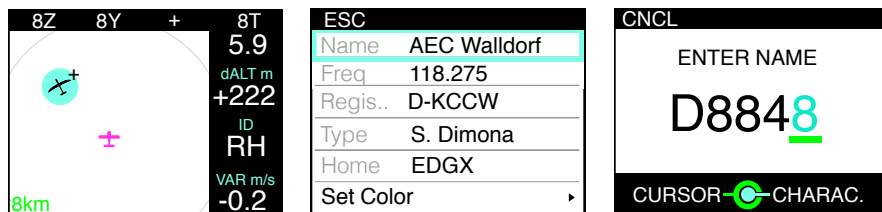

Figure 1.5.: Main radar page, menu, text input page. Inner knob always controls the cyan-colored elements, outer knob the green-colored elements.

### 1.2.4 Softkeys

Four “softkey”-pushbuttons are located on the top of the front bezel of the device. The softkey designators on top of the TFT display show the softkey’s current function. Softkey functions change depending on menu level and context.

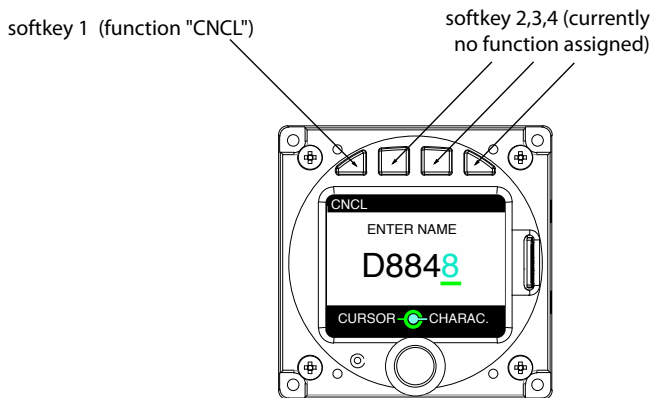

Figure 1.6.: Text-input page. The leftmost softkey has a function (CNCL means Cancel)

As an addition to its normal softkey functions, **softkey 1** is used for switching ATD ON or OFF with a long push.

### 1.2.5 Discrete Inputs

Physical toggle-switches can be connected during installation. A switch can be used to suppress all warnings. In one position (switch source exercised, GND), all warnings are switched off, in the other position ATD operates normally.

A switch can also be used to change the traffic-display orientation from “track-up” to “north up”. If the switch source is exercised, the orientation will be “north up”.

## 1.3 microSD Card Slot

A microSD card slot is located on the right side of the unit's front panel (ATD-57 and ATD-80) or on the left side of the unit (ATD-11). A microSD memory card can be inserted and removed from the device.

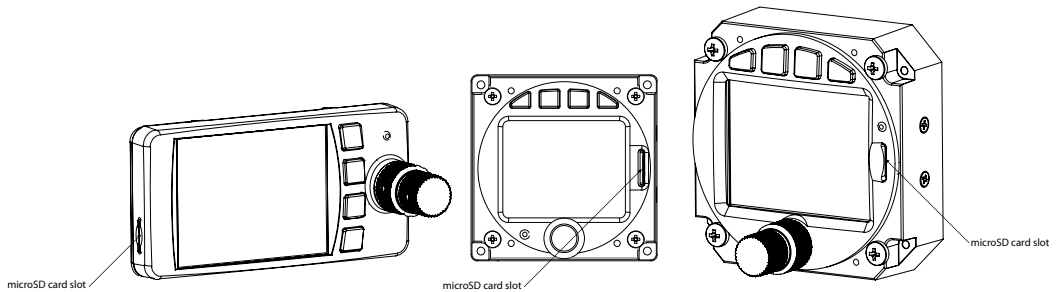

Figure 1.7.: microSD card slot

Please insert the microSD card while the unit is switched OFF. The microSD card will not be recognized if inserted during operation. If the microSD card is removed from the device, not all functions will be available.

To insert a microSD Card, insert the card into the slot, print facing to the display, little nose facing upwards and gently push the card until it clicks in.

Inserting the microSD card in wrong orientation may damage the slot.

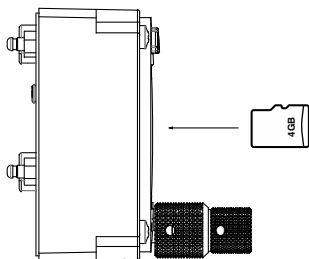

Figure 1.8.: microSD card in correct orientation for ATD-57/ATD-80

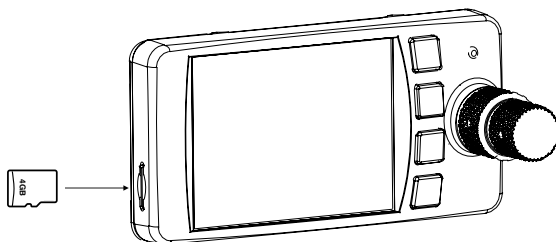

Figure 1.9.: microSD card in correct orientation for ATD-11

To remove an inserted microSD Card, use your fingernail to gently push on the card until a click is audible. The card will be released following the click. Use your fingernail to remove the card.

Be careful. Application of too much force may damage the slot.

## 1.4 Basic Operation

### 1.4.1 Power ON

ATD is automatically switched on if sufficient supply power is present.



Figure 1.10.: After ATD has been switched on, this screen is shown until data from a connected traffic receiver is available

If “Power On Mode” is set to “OFF” ATD can be switched on by pushing **softkey 1** longer than 2 seconds if it has been powered down using this button before (see below).

When turned on, ATD may power up connected avionics systems (if compatible) if they have not been powered up already.

#### 1.4.2 Power OFF

To power ATD off, disconnect ATD from supply power. If powered off this way, ATD always switches on again automatically if the supply power is restored.

If “Power On Mode” is set to “OFF”, ATD can be powered off by pushing **softkey 1** longer than 4 seconds. A special Power-Off screen is shown during the power-down process.

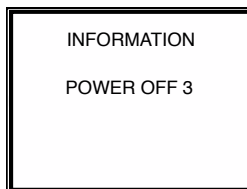

Figure 1.11.: Power-Off screen. The countdown timer on the right (here 3 seconds) counts down until the unit is switched off

## 1.5 Limitations and Safety Instructions

The flight crew is ultimately responsible for traffic avoidance. ATD does not intend to replace and may never distract from general practices of safe airmanship. Familiarization of specific installation conditions in an aircraft, e.g. number, type, and configuration of connected traffic systems is required before using ATD. Do not fly with ATD if you are unfamiliar with its operation and limitations.

It is the responsibility of those using this article to determine that the installation and

working conditions are within required standards. All limitations of connected traffic systems apply.

**This unit shall not be used as primary means of traffic avoidance. It shall be used as an aid for providing additional situational awareness only. ATD shall not be used if crew workload is increased.**

**Never make safety critical decisions based on information provided on the ATD alone.**

All screen shots used in this document are current at the time of publication. Screen shots are intended to provide visual reference only. All information depicted in screen shots, including software file names, versions, and part numbers, is subject to change and may not be up to date.

### 1.5.1 Liability

IN NO EVENT WILL AIR AVIONICS BE LIABLE FOR ANY INCIDENTAL, SPECIAL, INDIRECT OR CONSEQUENTIAL DAMAGES, WHETHER RESULTING FROM THE USE, MISUSE OR INABILITY TO USE THE PRODUCT OR FROM DEFECTS IN THE PRODUCT.

## 2.1 Main Radar View

ATD displays traffic data from connected traffic systems on a radar-like view. Traffic-targets are shown as aircraft symbols. The own ship-position is shown as a magenta aircraft symbol. A circle depicts the current display range (also shown numerically in the lower left hand corner of the screen). To adjust display range, please rotate the outer knob. The orientation is always track-up.

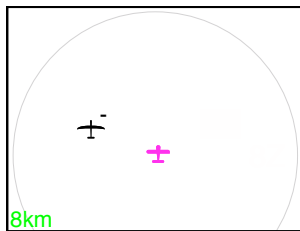

Figure 2.1.: Main Radar View

This screen is shown if “target selection” is not active. If target selection is active, additional information is shown on the screen. Please see below.

A physical toggle-switch can be connected during installation. In one position, traffic display orientation is normal (track-up), in the other position the traffic display orientation is “north-up”. Please consult the ATD installation manual for details on switch installation.

## 2.2 Target Symbology

### 2.2.1 Overview

Target symbology differentiates aircraft categories and states.



Figure 2.2.: Symbols for Motorplane (left), Glider, Helicopter, Hangglider, Jet, and drone (right)



Figure 2.3.: Symbol for circling aircraft (e.g. glider).

### 2.2.2 Target Relative Altitude

A small indicator on the right side of target symbols shows the targets relative altitude. A “+” shows that the target is above the own ship, a “-” below.



Figure 2.4.: Aircraft below (little minus-sign) and above (little plus-sign) the own ships current altitude.

Targets are always depicted in their actual relative altitude in relation to each other and the own ship-symbol.

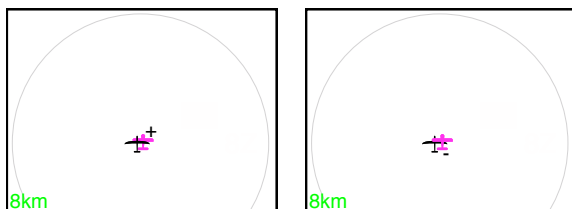

Figure 2.5.: Targets above and below the own ship

Target sizes differ depending on the target's relative altitude distance. Targets that are significantly higher or lower than the own ship are shown at a smaller scale.

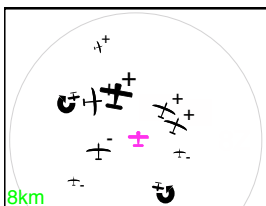

Figure 2.6.: Many targets with different relative altitudes and therefore different sizes on the screen.



### 2.2.3 Target Heading

Target symbols always resemble the targets current heading if available. The nose of the target symbol always shows into the direction the target is heading towards.

In some cases, no target heading is available, for example if the target is not received continuously or if the target's FLARM system and/or the own ship's FLARM system is configured to STEALTH mode<sup>1</sup>.

If no target heading is available, a diamond-shaped symbol is shown.



Figure 2.7.: Symbol for target with no target heading available

### 2.2.4 Nondirectional Targets

Some traffic systems, for example most Mode-S receivers, identify targets nondirectionally, i.e. for such targets only distance and vertical separation are known.

ATD displays the closest non-directional target as a dotted ring around the own ship symbol with a relative altitude indicator. The relative altitude is indicated in 100ft or 10m increments depending on unit configuration.

For example if "feet" is configured as the unit for altitude display, "+01" indicates the target being 100 feet higher than the own ship's current altitude. If "meters" is the unit configured for altitude display, "+01" indicates that the target is ten meters above the own ship's current altitude.

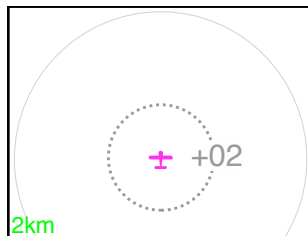

Figure 2.8.: Ring Indicator with relative altitude (+200ft / +20m) of a nondirectional target.

While many nondirectional targets may be received by the connected traffic system, ATD always only displays the closest target.

<sup>1</sup> For details, please consult FLARM documentation

# 3

## Target Selection

### 3.1 Overview

If target selection is activated, targets can be selected using the `inner knob`. The selected target is highlighted in cyan color. To change the selection, rotate the `inner knob`.

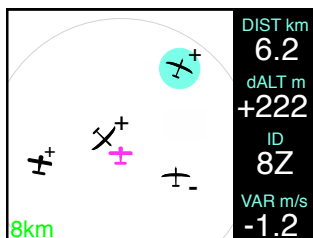

Figure 3.1.: Main radar view with active target selection. Details about the selected target (cyan highlight) are shown on the right.

Additional information about the selected target is shown on the right hand side of the radar view.

- Target horizontal distance to own ship (units configurable to Kilometers, Nautical Miles or Statute Miles)
- Target vertical distance to own ship (units configurable to Meters or Feet)
- Target identification (Aircraft Address or FLARMNet ID)
- Target vertical rate (units configurable to Meters per Second, Knots or Feet per Minute)

### 3.2 Target-Menu

To open the target-menu for the selected target, push once on the `inner knob pushbutton`. You can close the target menu by pushing the `ESC softkey`.

ESC	
Name	AEC Walldorf
Freq	118.275
Regis..	D-KCCW
Type	S. Dimona
Home	EDGX
Set Color	▶

Figure 3.2.: Target-Menu

For targets with FLARMNet<sup>1</sup> database information available, the target menu contains detailed FLARMNet information. If no database information is available for the target, only basic data is shown in the target menu.

For details on databases currently available, in the *CONFIGURATION MENU*, please navigate to *INFO* → *DATABASES*.

### 3.2.1 Target Display-Color

Target display-color can be user configured in four different colors. The color configuration is saved for a specific target. You can cancel color selection by pushing the **CNCL** softkey.

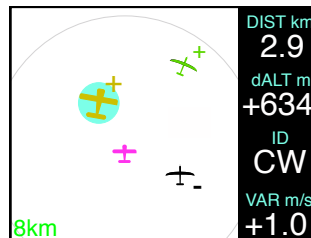
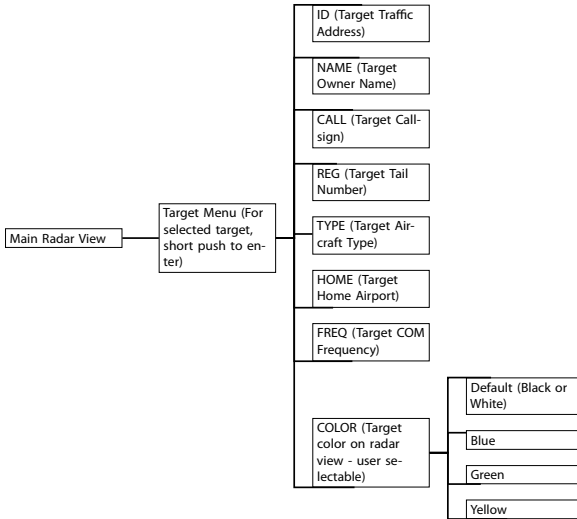

Figure 3.3.: One target colored in yellow (selected) and one target colored in green.

### 3.2.2 Target-Menu Structure

The following menu structure shows the target-menu and color selection.

<sup>1</sup>Please find more information about the FLARMNet database on [www.flarmnet.org](http://www.flarmnet.org)



### 3.3 Quick Selection

Up to four targets can be selected quickly using quick-select positions via **softkey 1 to 4**.

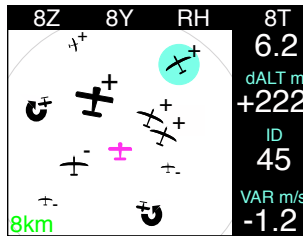

Figure 3.4.: Quick select positions (Four Softkeys on the top-row of the screen)

To quickly select a target, perform the following steps:

- Push any **softkey** to open the quick-selection softkey menu.
- To select a target, push on the corresponding **softkey**.

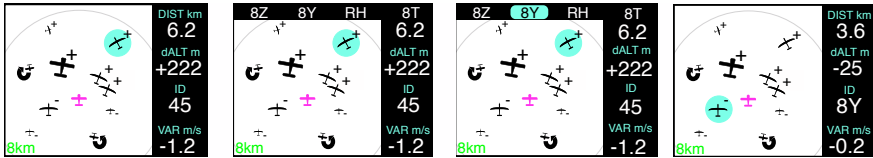

Figure 3.5.: Quick selection process: Radar Screen, busy traffic situation → push any softkey to open quick selection menu → push softkey for quick selection of target → target is selected

### 3.3.1 Editing Target Names on the Quick Select List

The targets on the quick select list can be given an individual name/ID. Perform the following steps to enter a name/ID:

1. Open the menu with a long push on the **inner knob pushbutton**.
2. Use the **inner knob** to navigate to *TRAFFIC VIEW* → *QUICK SELECT*
3. Use the **inner knob** to navigate to the desired target in the quick select list.
4. Push the **EDIT softkey** to open the edit dialog for the target. Enter a name.
5. Push the **inner knob pushbutton** to execute your selection.
6. Push the **ESC softkey** to leave the menu.

### 3.3.2 Managing the Quick Selection list

In addition to the processes described below, the Quick selection list can also be configured in *CONFIGURATION MENU* → *TRAFFIC VIEW* → *QUICK SELECT*.

#### Assignment

To assign a target to the quick select list, perform the following steps.

- Select the desired target on the radar view
- Push any **softkey** to open the quick-selection.
- A “+”-Sign indicates a free quick-select position. Push such a **softkey** with a “+”-sign to assign the target to the position.

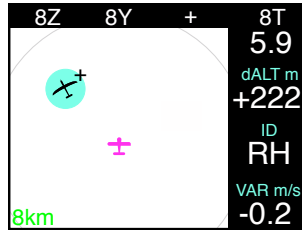

Figure 3.6.: Target assignment to quick select list. The Target can be assigned to the third position (little “+”-sign)

### Deletion

To delete a target from the quick select list, perform the following steps.

- Select the desired target on the radar view or via quick selection.
- Push any **softkey** to open the quick-selection.
- A “-”-Sign indicates the selected target’s current quick-select-position. Push the corresponding **softkey** to delete the target from the position.

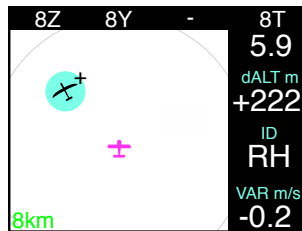

Figure 3.7.: Target deletion from quick select list. The target “RH” is in the list and currently selected. The little “-”-sign deletes it from the quick select menu and frees the space for a different target to be assigned.

## 3.4 Target Out-Of-Range

Whenever the signal of a target is lost, for example because it is out of the receiving range of the connected traffic system, the symbol disappears from the radar view.

Should the signal of a *selected* target or a target on the quick-selection-list be lost, ATD continues to track its probable position based on the last known position and maximum speed of the target. The following list shows the exact behavior:

- signal is lost, traffic symbol disappears, a cyan question-mark and a circle appears at the last known position.
- Over time, the question-mark fades out.

- The circle increases in size around the last known position of the target. The size increases with the maximum possible speed the formerly received target can fly (depends on target type). If the circle reaches the edge of the radar screen, it is displayed along the edge.

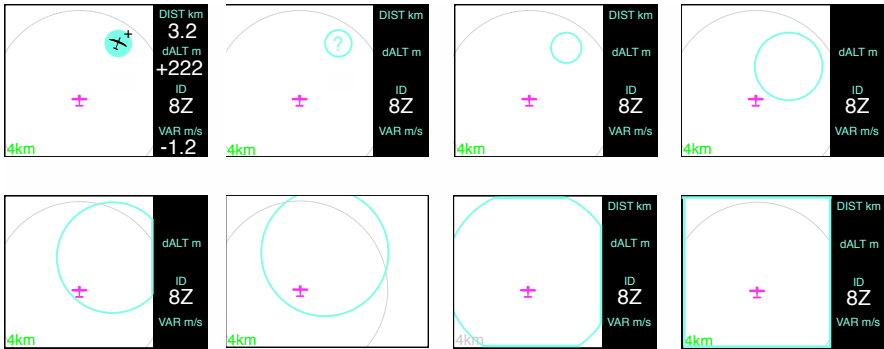

Figure 3.8.: Behavior over time when selected target signal is lost.

# 4

## Warning Functions

While ATD is capable of displaying warning messages, it does not compute threat- or warning-levels. Warning messages are always triggered by connected systems. Familiarization with limitations of connected systems is essential and recommended before using ATD.

Traffic warnings are displayed in two different warning screens depending on position of conflicting traffic.

In addition, aural beeps are emitted using the integral alert-sounder. Alert sounder volume is user-configurable.

Check alert sounder volume to be configured to an appropriate level before flight.

### 4.1 Normal Traffic Warnings

In case of a normal traffic warning, the conflicting target is highlighted on the radar view. The direction to the conflicting target is shown using an amber colored "beam".

Vertical separation is displayed numerically (depending on units configuration in 10 meters or 100 feet steps). Additionally an indicator on the right hand side of the screen shows the vertical viewing angle to the target in relation to the horizon. The display range is automatically adjusted to reflect the target's current distance<sup>1</sup>.

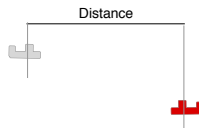

Figure 4.1.: Distance indication (based on horizontal separation)

<sup>1</sup>Indicated distances only refer to horizontal separation. Actual 3D distance is a function of vertical and horizontal separation and not displayed.



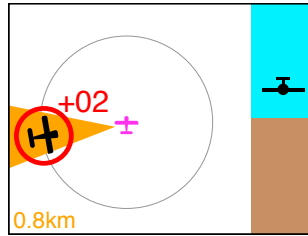

Figure 4.2.: Normal Traffic Warning Screen

The horizon style indicator does not provide for attitude reference of the own ship

## 4.2 Head-On Traffic Warnings

Conflicting head-on traffic is displayed using a “horizon-Style” indication depicting the conflicting target in a head-on symbology. The size of the conflicting target increases with decreasing distance. The edges of the screen depict 90 degree viewing angles.

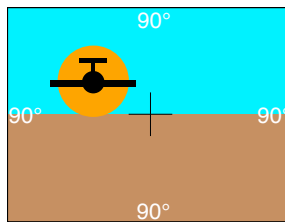

Figure 4.3.: Head-On Traffic Warning Screen

The horizon style indicator does not provide for attitude reference of the own ship

## 4.3 Nondirectional traffic warnings

In case of a warning from a nondirectional target, the ring-indicator is displayed in amber color.

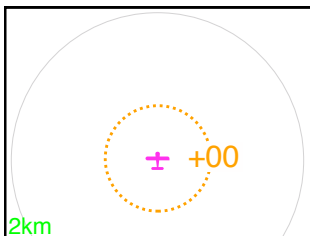

Figure 4.4.: Warning from nondirectional target (ring-indicator in amber, same altitude)

## 4.4 Obstacle Warnings

ATD is capable of displaying obstacle warnings, for example from a FLARM-Compatible device with obstacle database.

Obstacles are not shown on the radar screen. Please consult the documentation of the connected system for details about obstacle warnings.

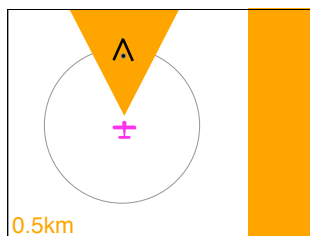

Figure 4.5.: Obstacle Warning Screen

## 4.5 Alert Zone Warnings

Please consult the documentation of the connected system for details about alert zone functions.

Alert zones are displayed on the radar view. An alert zone reference point, that is for example the center of a cylinder if the alert zone is cylindrical, is shown using a grey colored symbol representing the alert zone type.

Similar to traffic targets, a small indicator on the right side of the alert zone reference point symbols shows the relative altitude. A "+" shows that the alert zone is defined above the own ship, a "-" shows that the alert zone is defined below. If no indicator is shown, the own ship flies in the altitude band where the alert zone is defined.

Additionally the border of the alert zone is shown on the radar view as a grey colored line.

Alert zones are displayed in low contrast grey color to minimize interference with other display content on the radar view.

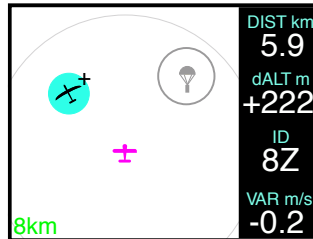

Figure 4.6.: Cylindrical alert zone with reference point and border (dropzone).

In some cases, an alert zone may not be visible on the radar view, for example because the display range is too low (zoom level too high), and the alert zone is too large. If inside an alert zone, a text indicator reading "INSIDE ZONE" is shown, indicating that the own ship is inside the alert zone.

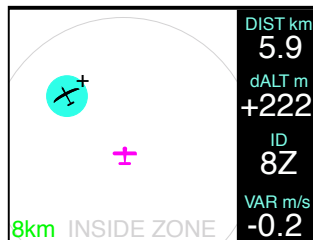

Figure 4.7.: Own ship inside an alert zone while the zone itself is not visible on the radar view, because the display range is too low (zoom level too high), and the own ship is inside the alert zone.

#### 4.5.1 Alert Zone Warnings

Whenever the connected system issues an alert zone warning, corresponding items on the radar screen (zone border and reference point) are highlighted using a light-grey colored "beam" pointing into the direction of the reference point for the alert zone.

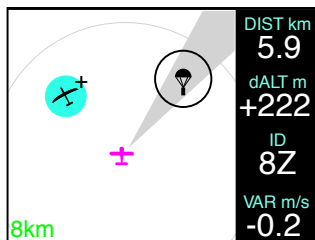

Figure 4.8.: Alert zone warning screen with zone visible on the radar view, own ship outside the alert zone. Beam points into the direction of the alert zone reference point.

## 4.6 Suppressing Warnings

Warning messages (aural annunciation and warning display) can be suppressed for a time of two minutes by pushing twice (doubleclicking) on the inner knob pushbutton. Warning functions can be immediately restored by pushing twice (doubleclicking) again.

There will be no warnings of conflicting traffic or obstacles while warnings are suppressed

While warnings are suppressed, a special indication on the display appears.



Figure 4.9.: "NO WARNINGS" message appears for the time, warnings are suppressed.

### 4.6.1 No Warnings Switch

A physical toggle-switch can be connected during installation. In one position, all warnings are suppressed, in the other position ATD operates normally. Please consult the ATD installation manual for details on switch installation.

## 5.1 Configuration Operations

### 5.1.1 Configuration Menu

ATD-57 is configured in the configuration menu. To enter the configuration menu, push the **inner knob pushbutton** for at least 2 seconds (long push). The menu contains several configuration options and informations about ATD-57 and connected systems.

Please find a menu diagram in appendix A

### 5.1.2 Configuration Reset to Defaults

In order to reset the system configuration to factory defaults, please perform the following steps:

1. Disconnect the device from power.
2. Press and hold **softkey 3** and **softkey 4** while connecting the device to power. Keep holding the softkeys until the device has booted.
3. All settings are now reset to the factory defaults.

All settings will be reset. This process can not be undone. After factory defaults have been applied the device is no longer in an airworthy configuration state. All configuration operations have to be conducted again.

## 5.2 Device Configuration

In the configuration menu, *DEVICE* contains specific configuration parameters and information about the ATD-57 device itself.

### 5.2.1 Alert Sounder Volume

ATD-57 features an integrated alert sounder (buzzer) for warning annunciation. The alert sounder volume can be adjusted to meet individual installation requirements. The default for this value is 3.

To change the alert sounder volume, please carry out the following steps:

1. Open the menu with a long push on the **inner knob pushbutton**.
2. Use the **inner knob** to navigate to *DEVICE* → *SOUNDER VOLUME*.
3. Use the **inner knob** to select a desired volume.

4. Push the **inner knob pushbutton** to execute your selection.
5. Push the **ESC softkey** to leave the menu.

## 5.2.2 HMI Illumination Brightness Control

Human machine interface (HMI) illumination brightness (screen and buttons) can be controlled using independent methods, only one brightness control method can be used at a time.

- Manual brightness control - Brightness at a set value (user adjustable).
- Automatic brightness control - Automatic adjustment using the ambient light sensor
- Brightness control over aircraft lighting bus - using one of the lighting bus inputs

For aircraft operating at night, the aircraft lighting bus input must be used.

The value for manual, minimum, and maximum illumination levels can be configured individually. Aircraft lighting bus source and minimum/maximum voltage values can as well be configured.

Please note that some changes like minimum and maximum illumination level require a system restart before they take effect.

### Manual Brightness Control

To change the HMI illumination mode to manual brightness control, please carry out the following steps:

1. Open the menu with a long push on the **inner knob pushbutton**.
2. Use the **inner knob** to navigate to *DEVICE* → *INSTALLATION* → *ILLUMINATION* → *MODE*.
3. Use the **inner knob** to select *MANUAL*.
4. Push the **inner knob pushbutton** to execute your selection.
5. Push the **ESC softkey** to leave the menu.

Now the brightness level as configured in *MANUAL INTENSITY* is used.

### Automatic Brightness Control

To change the HMI illumination mode to automatic brightness control, please carry out the following steps:

1. Open the menu with a long push on the **inner knob pushbutton**.
2. Use the **inner knob** to navigate to *DEVICE* → *INSTALLATION* → *ILLUMINATION* → *MODE*.
3. Use the **inner knob** to select *AUTO*.
4. Push the **inner knob pushbutton** to execute your selection.
5. Push the **ESC softkey** to leave the menu.

Now the brightness level is adjusted using the ambient light sensor in the front bezel of the device. Restrictions to minimum and maximum brightness levels are configured in *MINIMUM* and *MAXIMUM*.

### Brightness Control over Aircraft Lighting Bus

In order to use the aircraft lighting bus, the following configuration actions have to be taken:

1. change HMI illumination mode
2. configure the input pin used
3. configure input voltage levels

To change the HMI illumination mode to aircraft lighting bus, please carry out the following steps:

1. Open the menu with a long push on the **inner knob pushbutton**.
2. Use the **inner knob** to navigate to *DEVICE* → *INSTALLATION* → *ILLUMINATION* → *MODE*.
3. Use the **inner knob** to select *LIGHTINGBUS*.
4. Push the **inner knob pushbutton** to execute your selection.
5. Push the **ESC softkey** to leave the menu.

To configure the correct input pin for the lighting bus, please carry out the following steps:

1. Open the menu with a long push on the **inner knob pushbutton**.
2. Use the **inner knob** to navigate to *DEVICE* → *INSTALLATION* → *ILLUMINATION* → *LIGHTING BUS* → *LIGHT. BUS SRC*.
3. Use the **inner knob** to select *select the pin, the aircraft lighting bus is connected to (USENS1 or USENS2)*.
4. Push the **inner knob pushbutton** to execute your selection.
5. Push the **ESC softkey** to leave the menu.

Now the brightness level is adjusted using the configured lighting bus input pin. To configure desired voltage levels for minimum and maximum brightness, please carry out the following steps:

1. Open the menu with a long push on the **inner knob pushbutton**.
2. Use the **inner knob** to navigate to *DEVICE* → *INSTALLATION* → *ILLUMINATION* → *LIGHTING BUS* → *LIGHT. BUS MIN*.
3. set the aircraft lighting bus to the minimum level using the lighting bus control in your aircraft.
4. Push the **inner knob pushbutton** to execute your selection.
5. Use the **inner knob** to navigate to *DEVICE* → *INSTALLATION* → *ILLUMINATION* → *LIGHTING BUS* → *LIGHT. BUS MAX*.

6. set the aircraft lighting bus to the maximum level using the lighting bus control in your aircraft.
7. Push the **inner knob pushbutton** to execute your selection.
8. Push the **ESC softkey** to leave the menu.

### 5.2.3 Power On Mode

“Power On Mode” is typically active (set to ON) in order to always automatically switch ATD-57 on if sufficient supply power is present. By setting the Power On Mode to OFF ATD-57 ignores supply power and is switched on by pushing **softkey 1**.

As mentioned above, the default setting for this parameter is ON. To change Power On Mode configuration, please carry out the following steps:

1. Open the menu with a long push on the **inner knob pushbutton**.
2. Use the **inner knob** to navigate to *DEVICE* → *INSTALLATION* → *POWER ON MODE*.
3. Push the **inner knob pushbutton** to toggle between ON and OFF.
4. Push the **ESC softkey** to leave the menu.

### 5.2.4 Data Ports

ATD-57 can receive traffic data from an *AIR Traffic*, *FLARM*, *PowerFLARM* or from a *GARMIN TIS* data source. The data source can be connected to either one of the two independent RS-232 data ports of the ATD-57.

To change the data port configuration, please carry out the following steps:

1. Open the menu with a long push on the **inner knob pushbutton**.
2. Use the **inner knob** to navigate to *DEVICE* → *INSTALLATION* → *DATA PORTS* → *PORT 1* or *DEVICE* → *INSTALLATION* → *DATA PORTS* → *PORT 2*.
3. Use the **inner knob** to select a source: *AT-1*, *FLARM*, *PowerFLARM*, *GARMIN TIS* or *NOT CONNECTED*.
4. Push the **inner knob pushbutton** to execute your selection.
5. Push the **ESC softkey** to leave the menu.

### 5.2.5 Switches

Two toggle switches may be optionally installed and connected to the two discrete inputs. A toggle switch either suppresses all alarms, or changes traffic-display orientation to “north up” if the switch source is exercised.

The *NO WARNINGS* and *ORIENTATION* functions can be individually mapped to input 1 (on the upper connector) and input 2 (on the lower connector).

To change the switch configuration, please carry out the following steps:

1. Open the menu with a long push on the **inner knob pushbutton**.



2. Use the **inner knob** to navigate to *DEVICE* → *INSTALLATION* → *SWITCHES* → *NO WARNINGS* or *DEVICE* → *SWITCHES* → *ORIENTATION*.
3. Use the **inner knob** to select a source: *IN1* (input on upper connector), *IN2* (input on lower connector), or *NOT CONNECTED*.
4. Push the **inner knob pushbutton** to execute your selection.
5. Push the **ESC softkey** to leave the menu.

### 5.2.6 Info

In the *DEVICE* menu, *INFO* contains specific information about the ATD-57 device such as hardware and software version information and the version of the database on the microSD card (if present).

## 5.3 Traffic View Configuration

In the configuration menu, *TRAFFIC VIEW* holds data display and user interface parameters.

### 5.3.1 Units

Units for distance, altitude and vertical speed are configurable:

- Distance: kilometers, nautical miles, or statute miles.
- Altitude: meters or feet.
- Vertical rate: meters per second, feet per minute, or knots.

To change the units configuration, please carry out the following steps:

1. Open the menu with a long push on the **inner knob pushbutton**.
2. Use the **inner knob** to navigate to *TRAFFIC VIEW* → *INSTALLATION* → *UNITS* → *DISTANCE*, *ALTITUDE*, or *VERT RATE*.
3. Use the **inner knob** to select the desired unit.
4. Push the **inner knob pushbutton** to execute your selection.
5. Push the **ESC softkey** to leave the menu.

### 5.3.2 Dark Style

Main display colors can be selected to be black on white (default) or white on black. “Dark Style” (white on black) is recommended for night flying.

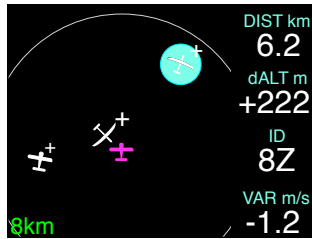

Figure 5.1.: Dark Style switched on

To activate “Dark Style”, please carry out the following steps:

1. Open the menu with a long push on the **inner knob pushbutton**.
2. Use the **inner knob** to navigate to *TRAFFIC VIEW* → *INSTALLATION* → *DARK STYLE*.
3. Push the **inner knob pushbutton** to toggle between ON and OFF.
4. Push the **ESC softkey** to leave the menu.

### 5.3.3 Quick Select

In *CONFIGURATION MENU* → *VIEW* → *QUICK SELECT* the quick selection target list can be managed. For details about using this feature, please consult section “Quick Selection” on page 14.

### 5.3.4 Own Ship Symbol

The aircraft symbol (own ship) can be configured to either resemble a motorplane, helicopter or a glider.

Aircraft Symbol settings do not have effect on aircraft type settings in the connected traffic system.



Figure 5.2.: own ship aircraft symbols for motorplane (left) and glider (right)

To change the own ship symbol, please carry out the following steps:

1. Open the menu with a long push on the **inner knob pushbutton**.
2. Use the **inner knob** to navigate to *TRAFFIC VIEW* → *INSTALLATION* → *OWN-SHIP*.
3. Use the **inner knob** to select the desired symbol.
4. Push the **inner knob pushbutton** to execute your selection.
5. Push the **ESC softkey** to leave the menu.

### 5.3.5 Target Select

If target selection is activated, targets can be selected using the **inner knob**. The selected target is highlighted in cyan color. Additional information about the selected target is shown on the right hand side of the radar view. If target selection is not active, the radar screen is larger and no additional information is shown.

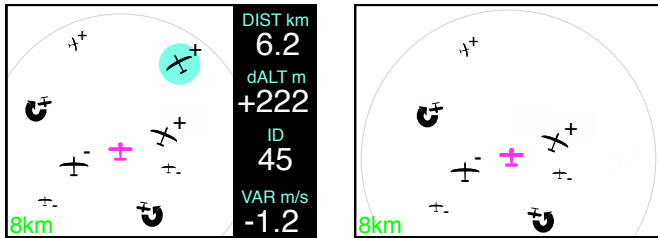

Figure 5.3.: Target select active (left) and not active (right)

To change "Target Select" settings, please carry out the following steps:

1. Open the menu with a long push on the **inner knob pushbutton**.
2. Use the **inner knob** to navigate to *TRAFFIC VIEW* → *INSTALLATION* → *TARGET SELECT*.
3. Push the **inner knob pushbutton** to toggle between ON and OFF.
4. Push the **ESC softkey** to leave the menu.

### 5.3.6 Head-On Alarm

If the head-on traffic warning screen is deactivated all traffic warnings, also those from head-on traffic are displayed using the normal traffic warning screen.

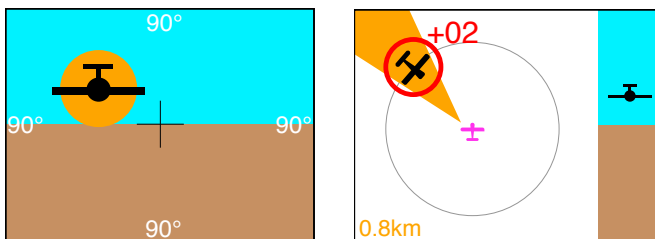

Figure 5.4.: Head-On Alarm active (left) and not active (right)

To change Head-On Alarm settings, please carry out the following steps:

1. Open the menu with a long push on the **inner knob pushbutton**.
2. Use the **inner knob** to navigate to *VIEW* → *INSTALLATION* → *HEAD-ON ALARM*.
3. Push the **inner knob pushbutton** to toggle between ON and OFF.

4. Push the ESC softkey to leave the menu.

## 5.4 Traffic System Configuration

In the configuration menu, *PORTXDEVICE* holds configuration parameters for the connected traffic system on the specific data port.

- *INFO* contains information about the connected traffic system.
- *STATUS* contains status informations of the connected traffic system.
- *SETTINGS* allows for configuration of the connected traffic system.

Configuration and information display are only possible in specific installation cases and with some traffic systems. A bidirectional data connection is required. If the specific parameter can not be read or configured, the value “-” appears.

Please consult the documentation of the connected traffic system for available setup parameters and their recommended values.

## 6.1 Version Identification

Software version can be reviewed in *CONFIGURATION MENU* → *DEVICE* → *INFO*.

For details on databases currently available, navigate to *CONFIGURATION MENU* → *DEVICE* → *INFO* → *DATABASES*.

## 6.2 Software and Database Loading

Software upgrades and databases are loaded using the integrated microSD card slot and a microSD memory card.

While the software is actually loaded onto the device, the database remains on the microSD card. Therefore database information is only accessible if the microSD card is installed.

If the microSD card is not installed, not all functions will be available.

Never remove the microSD card while the device is in operation. If the microSD card is removed from the device during runtime, the device's software may stop working. In this case a system restart would be required.

### 6.2.1 microSD Card Slot

A microSD card slot is located on the right side of the unit's front panel. A microSD memory card can be inserted and removed from the device.

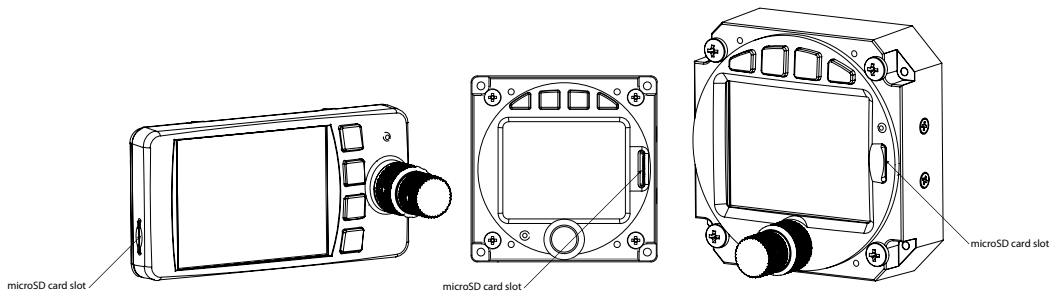

Figure 6.1.: microSD Card Slot

To insert a microSD card, insert the card into the slot, print facing to the display, little nose

facing upwards for ATD-57 and ATD-80 or downwards for ATD-11 with controls on the right. Gently push the card until it clicks in.

Inserting the microSD card in the wrong orientation may damage the slot.

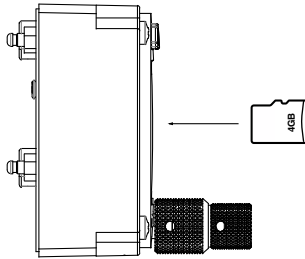

Figure 6.2.: microSD card in correct orientation for ATD-57 and ATD-80

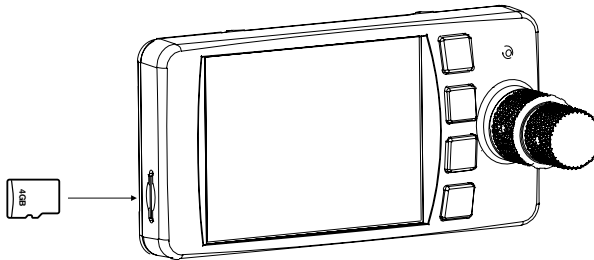

Figure 6.3.: microSD card in correct orientation for ATD-11

To remove an inserted microSD card, use your fingernail to gently push on the card until a click is audible. The card will be released following the click. Use your fingernail to remove the card.

Be careful. Application of too much force may damage the slot.

ATD is compatible to all FAT or FAT32 formatted microSD cards. It has been successfully tested with microSD cards with a storage size of 2 to 64 gigabytes.

## 6.2.2 Loading Software to ATD

In order to perform a software update, please carry out the following steps:

1. Load a valid ATD firmware file onto a microSD card.
2. Insert the microSD card into the unit.

3. Power the unit on. An update message will appear.
4. Once the update process has been completed, verify the correct software version and function by repeating all configuration, checkout, and documentation steps.
5. Update required documentation.

### 6.2.3 Special Update Instructions from Version 1.3 to 1.5

The update to version 1.5 requires a two step process including an update of the ATD “bootloader”. A bootloader is the piece of software that handles the update process on the device.

A stable power supply is required for bootloader updates. Never disconnect power during the process. This might damage the device beyond repair.

1. Ensure software version 1.3 is installed. Update any earlier versions to 1.3.
2. Load bootloader update file (AD57BL\_VER\_1\_7.abl) onto an empty microSD card.
3. Insert the microSD card into the unit.
4. Power the unit on. In the *CONFIGURATION MENU*, please navigate to *DEVICE* → *INFO* → *HW AND BL* → *UPDATE BOOTLOADER*.
5. Turn the **(inner knob)** to start the update process.
6. Once the update process has been completed, perform software update to version 1.5 or later normally (as described above).

Please make sure that always only one update file is present on the microSD card at a time. Multiple files on the microSD card will cause the device to not update properly.

### 6.2.4 Special Update Instructions from Version 1.5 or 1.7 to 1.8 or later

The update to version 1.8 requires a two step process including an update of the ATD “bootloader”. A bootloader is the piece of software that handles the update process on the device.

A stable power supply is required for bootloader updates. Never disconnect power during the process. This might damage the device beyond repair.

1. Ensure software version 1.7 is installed. Update any earlier versions to 1.7.
2. Load bootloader update file (AD57BL\_VER\_2\_6.abl) onto an empty microSD card.
3. Insert the microSD card into the unit.
4. Power the unit on. In the *CONFIGURATION MENU*, please navigate to *DEVICE* → *INFO* → *HW AND BL* → *UPDATE BOOTLOADER*.
5. Turn the **(inner knob)** to start the update process.
6. Once the update process has been completed, perform software update to version 1.8 or later normally (as described above).

Please make sure that always only one update file is present on the microSD card at a time. Multiple files on the microSD card will cause the device to not update properly.



## 7.1 Insufficient Data

ATD requires a set of data from a connected traffic systems to work properly. ATD continuously seeks to find data on its data interfaces. It automatically switches data-transfer-rates and configuration until it receives data.

- Position Data (e.g. GPS coordinates)
- Traffic Data

### 7.1.1 No Data from Traffic System

ATD requires data from a connected traffic system wor work properly. A message indicates that no data is received. For example during the boot process of a connected traffic system this message may appear for up to 4 minutes.



Figure 7.1.: ATD not receiving data from a traffic system

### 7.1.2 No Position Data

For some functions, ATD requires position data. A message indicates that no position data is available. For example during the boot process of a connected traffic system this message may appear for up to several minutes.

If no GPS position is available, only nondirectional traffic can be displayed.

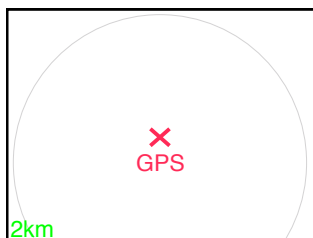

Figure 7.2.: ATD does not know the position. “NO GPS” message instead of own ship symbol is shown. Nondirectional ring-indicator is shown.

### 7.1.3 No Heading Data

ATD computes the current heading of the own ship from position data. In order to compute a heading, the own ship has to move.

If there is no movement, a heading can not be detected. In this case a message indicates that the current radar-display is NORTH UP. When standing still or taxiing slowly, this is normal behaviour.

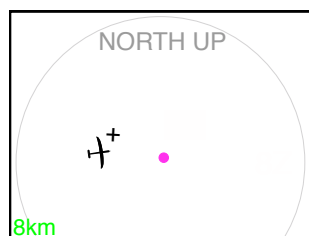

Figure 7.3.: NORTH UP Message

If no heading data is available, some informations are omitted in case of traffic warnings. For example the head-on warning screen is not used and the amber-colored highlight is not displayed.

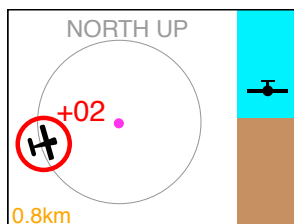

Figure 7.4.: Warning screen without heading data available

## 7.2 Failures

ATD features a range of built-in self test features that continuously monitor its system state and the state of connected traffic systems to detect failures. The detection of a failure is always annunciated to flightcrew on the display.

Depending on detected failure and failure severity, the system may seize to function or functionality may be limited. Failure-messages either close automatically, can be closed by flightcrew, or can not be closed depending on failure severity.



Figure 7.5.: Failure in connected traffic system is detected.

# 8

## Troubleshooting

### 8.0.1 My unit always shows a message “waiting for traffic..”

In this case, no data from a traffic system is received by ATD.

1. Check if wiring is correct and as intended
2. Check if configuration of connected traffic system is correct and compatible to ATD
3. check if connected traffic system is running normally

### 8.0.2 My unit always shows a red cross and a “GPS” sign above the place, where the own ship symbol should be.

The connected traffic system does not have a gps-signal or does not transfer the gps-signal to ATD.

1. If possible check if connected traffic system has a valid GPS fix. If so, check configuration of connected traffic system if GPS-data is transferred correctly.
2. Check GPS antenna of connected traffic system.
3. Consult vendor of connected traffic system for support.

### 8.0.3 My unit does not show traffic.

The connected traffic system does not send traffic data.

1. If possible check if connected traffic system receives traffic. If so, check configuration of connected traffic system if traffic-data is transferred correctly.
2. Check traffic antenna of connected traffic system.
3. Consult vendor of connected traffic system for support.

### 8.0.4 My unit shows too many traffic items, it is hard to read/interpret.

Traffic filter and range settings may not be beneficial.

1. Check configuration of connected traffic system for range settings.
2. Limit range settings of connected traffic system to an appropriate value.

### 8.0.5 The screen goes black when switched ON while a microSD card is inserted

This is a known issue with some microSD cards in the earliest software version 1.0 of AIR Traffic Display.

1. Please update the device software to the latest version. Any version newer than 1.0 will resolve the issue.
2. If an update is not possible for the moment, please go to menu > installation > illumination and set illumination mode to "AUTO". After this, the unit will work normally with microSD card inserted.

#### 8.0.6 Quick Selection: Adding a target. Only a "--" is shown.

This is normal behavior. The minus-sign ("–") allows for deleting the assigned target from the position. To verify the assignment is correct. Please select a different target and open the quick selection list again.

# A

## Configuration Menu Diagram

For better readability, the menu diagram is split into multiple separate parts on different pages of this manual.

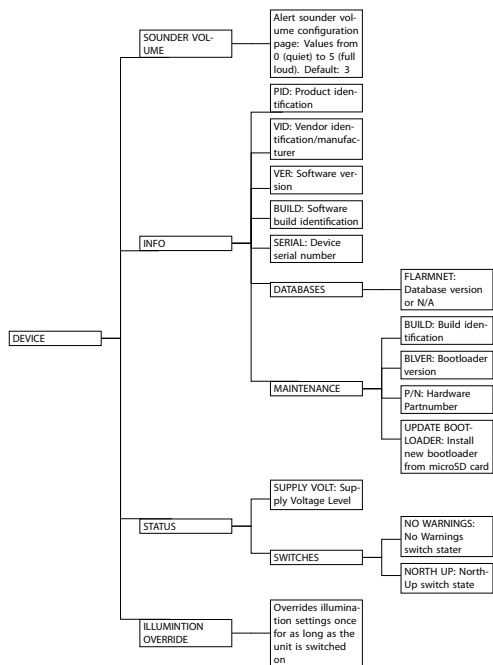

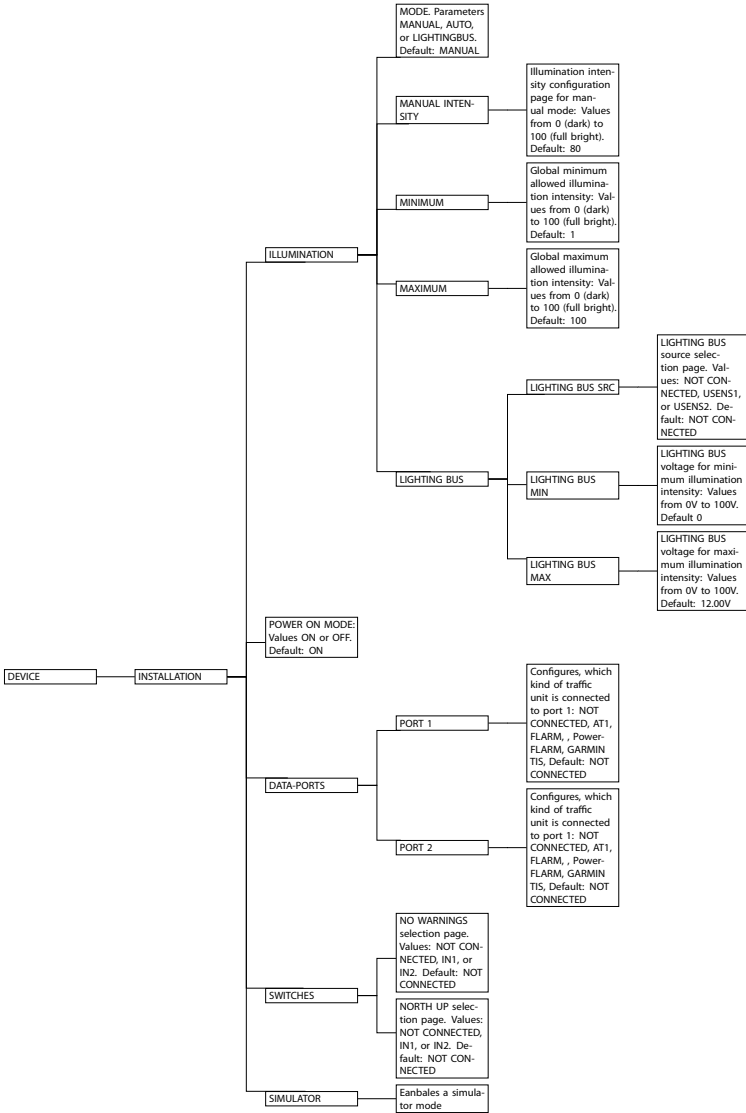

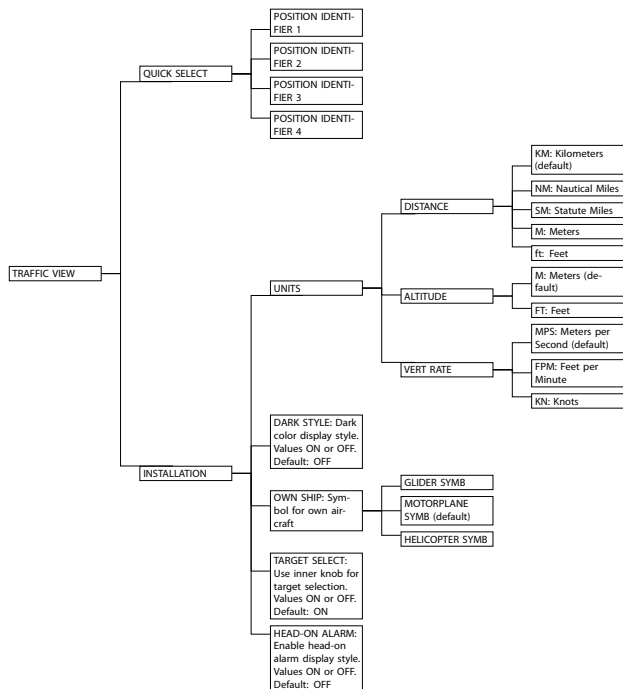

PORT 1 DEVICE:  
Device specific information and parameters for the traffic system connected to Port 1

PORT 2 DEVICE:  
Device specific information and parameters for the traffic system connected to Port 2



This appendix contains the End User License Agreement issued by FLARM Technology Ltd., the licensor of FLARM devices.

By purchasing or using a FLARM device or by downloading, installing, copying, accessing, or using any FLARM Technology Ltd. (hereafter “FLARM Technology”) software, firmware, license key, or data, you agree to the following terms and conditions. If you do not agree with the terms and conditions do not purchase or use the FLARM device and do not download, install, copy, access, or use the software, firmware, license key, or data. If you are accepting these terms and conditions on behalf of another person, company, or other legal entity, you represent and warrant that you have full authority to bind that person, company, or legal entity to these terms and conditions. If you are purchasing or using a FLARM device, the terms “firmware”, “license key”, and “data” refer to such items installed or available in the FLARM device at time of purchase or use, as applicable.

## 1. License and Limitation of use

### 1.1. License

Subject to the terms and conditions of this Agreement, FLARM Technology hereby grants to you a non-exclusive, non-transferable right to download, install, copy, access, and use the software, firmware, license key, or data in binary executable form solely for your own personal or internal business operations. You acknowledge that the software, firmware, license key, or data and all related information are proprietary to FLARM Technology and its suppliers.

### 1.2. Limitation of use

Firmware, license keys, and data may only be used as embedded in and for execution on devices manufactured by or under license from FLARM Technology. License keys and data may only be used in the specific devices, by serial number, for which they were sold or intended. Software, firmware, license keys, and data with an expiration date may not be used after the expiration date. Right to download, install, copy, access, or use software, firmware, license key, or data with an expiration date does not imply right to upgrade or extension of the license beyond the expiration date. No other licenses are granted by implication, estoppel or otherwise.

## 2. Terms of use of FLARM

### 2.1.

Every FLARM installation must be approved by licensed Part-66 certifying staff or the national equivalent. A FLARM installation requires an EASA Minor Change Approval or the national equivalent.

## 2.2.

FLARM must be installed according to the Installation Instructions and the EASA Minor Change Approval, or the national equivalent.

## 2.3.

FLARM cannot warn in all situations. In particular warnings may be incorrect, late, missing, not being issued at all, show other threats than the most dangerous or distract the pilot's attention. FLARM does not issue resolution advisories. FLARM can only warn of aircraft that are equipped with FLARM, SSR transponders (in specific FLARM devices), or of up-to-date obstacles stored in its database. The use of FLARM does not allow a change of flight tactics or pilot behavior. It is the sole responsibility of the pilot in command to decide upon the use of FLARM.

## 2.4.

FLARM may not be used for navigation, separation, or under IMC.

## 2.5.

FLARM does not work if GPS is inoperative, degraded, or unavailable for any reason.

## 2.6.

The most recent Operating Manual must be read, understood and followed at all times.

## 2.7.

The firmware must be replaced once per year (every 12 months). The firmware must also be replaced earlier if a Service Bulletin or other information is published with such instruction. Failure to replace the firmware may render the device inoperable or incompatible with other devices, with or without warning or notice thereof.

## 2.8.

Service Bulletins are published as a Newsletter by FLARM Technology. You are required to sign up for the Newsletter on [www.flarm.com](http://www.flarm.com) to ensure that you are informed of published Service Bulletins. If you are entering into this agreement in a form where your email address is available (e.g. online shop) you may be automatically signed up for the Newsletter.

## 2.9.

After power-up, FLARM performs a self-test which must be monitored by the pilots. If a malfunction or defect is observed or suspected, FLARM must be disconnected from the aircraft by maintenance before the next flight and the device inspected and repaired, as applicable.

## 2.10.

The pilot in command is solely responsible to operate FLARM according to applicable national regulations. Regulations might include, but are not limited to, airborne usage of radio frequencies, aircraft installation, safety regulations, or regulations for sports competitions.

### 3. Intellectual Property

No part of the software, firmware, license keys, data (including obstacle databases), the FLARM radio protocol and messages, and the FLARM hardware and design may be copied, altered, reverse engineered, decompiled or disassembled without an explicit and written approval by FLARM Technology. Software, firmware, license keys, data (including obstacle databases), the FLARM radio protocol and messages, the FLARM hardware and design, and the FLARM logos and name are protected by copyright, trademark and patent laws.

### 4. Manipulation

It is forbidden to intentionally feed artificially generated signals to the FLARM device, its GPS antenna or the external/internal GPS antenna connections.

### 5. FLARM Data and Privacy

#### 5.1.

FLARM devices receive, collect, store, use, send, and broadcast data to enable the system to work, improve the system, and to enable troubleshooting. This data may include, but is not limited to, configuration items, aircraft identification, own positions, and such data of other aircraft. FLARM Technology may receive, collect, store, and use this data for said purposes and in addition for Search and Rescue (SAR) purposes.

#### 5.2.

FLARM Technology may share data with its partners for aforementioned purposes. FLARM Technology may in addition publicly make available data from a FLARM device (Flight Tracking), unless the FLARM device in question has been configured to limit tracking. If a FLARM device has been configured to limit tracking, SAR and other services may not be available.

#### 5.3.

Data sent or broadcast by FLARM devices may only be used at own risk and under the same conditions as the FLARM device itself. FLARM Technology is not responsible for any third party device, software, or service receiving, collecting, storing, using, sending, broadcasting, or making publically available data regardless of whether legally or illegally.

### 6. Warranty, Limitation of Liability, and Indemnification

#### 6.1.

**Warranty.** FLARM devices, software, firmware, license keys, and data are provided on an “as is” basis without warranty of any kind — either expressed or implied — including, without limitation, any implied warranties of merchantability or fitness for a particular purpose. FLARM Technology does not warrant the performance of the device, software, firmware, license key, or data or that the device, software, firmware, license key, or data will meet your requirements or operate error free.

## 6.2.

**Limitation of Liability.** In no event shall FLARM Technology be liable to you or any party related to you for any indirect, incidental, consequential, special, exemplary, or punitive damages (including, without limitation, damages for loss of business profits, business interruption, loss of business information, loss of data or other such pecuniary loss), whether under a theory of contract, warranty, tort (including negligence), products liability, or otherwise, even if FLARM Technology has been advised of the possibility of such damages. In no event will FLARM Technology's total aggregate and cumulative liability to you for any and all claims of any kind arising hereunder exceed the amount of fees actually paid by you for the device, license keys or data giving rise to the claim in the twelve months preceding the claim. The foregoing limitations will apply even if the above stated remedy fails of its essential purpose.

## 6.3.

**Indemnification.** You will, at your own expense, indemnify and hold FLARM Technology, and all officers, directors, and employees thereof, harmless from and against any and all claims, actions, liabilities, losses, damages, judgments, grants, costs, and expenses, including reasonable attorneys' fees (collectively, "Claims"), arising out of any use of a FLARM device, software, firmware, license key, or data by you, any party related to you, or any party acting upon your authorization.

# 7. General terms

## 7.1.

**Governing Law.** This Agreement shall be governed by and construed in accordance with the internal law of Switzerland (to the exclusion of Swiss Private International Law and of international treaties, in particular the Vienna Convention on the International Sale of Goods dated April 11, 1980).

## 7.2.

**Severability.** If any term or provision of this Agreement is declared void or unenforceable in a particular situation, by any judicial or administrative authority, this declaration shall not affect the validity or enforceability of the remaining terms and provisions hereof or the validity or enforceability of the offending term or provision in any other situation. To the extent possible the provision will be interpreted and enforced to the greatest extent legally permissible in order to effectuate the original intent, and if no such interpretation or enforcement is legally permissible, shall be deemed severed from the Agreement.

## 7.3.

**Headings.** The Article and Section headings contained in this Agreement are included for reference purposes only and shall not affect the meaning or interpretation of this Agreement.

## 7.4.

**No Waiver.** The failure of either party to enforce any rights granted hereunder or to take action against the other party in the event of any breach hereunder shall not be deemed a

waiver by that party as to subsequent enforcement of rights or subsequent actions in the event of future breaches.

#### 7.5.

Amendments. FLARM Technology reserves the right, in its sole discretion, to amend this Agreement from time to time by posting an updated version of the Agreement on [www.flarm.com](http://www.flarm.com), provided that disputes arising hereunder will be resolved in accordance with the terms of the Agreement in effect at the time the dispute arose. We encourage you to review the published Agreement from time to time to make yourself aware of changes. Material changes to these terms will be effective upon the earlier of (i) your first use of the FLARM device, software, firmware, license key, or data with actual knowledge of such change, or (ii) 30 days from publishing the amended Agreement on [www.flarm.com](http://www.flarm.com). If there is a conflict between this Agreement and the most current version of this Agreement, posted at [www.flarm.com](http://www.flarm.com), the most current version will prevail. Your use of the FLARM device, software, firmware, license key, or data after the amended Agreement becomes effective constitutes your acceptance of the amended Agreement. If you do not accept amendments made to this Agreement, then it is your responsibility to stop using the FLARM device, software, firmware, license key, and data.

#### 7.6.

Governing Language. Any translation of this Agreement is done for local requirements and in the event of a dispute between the English and any non-English versions, the English version of this Agreement shall govern.